

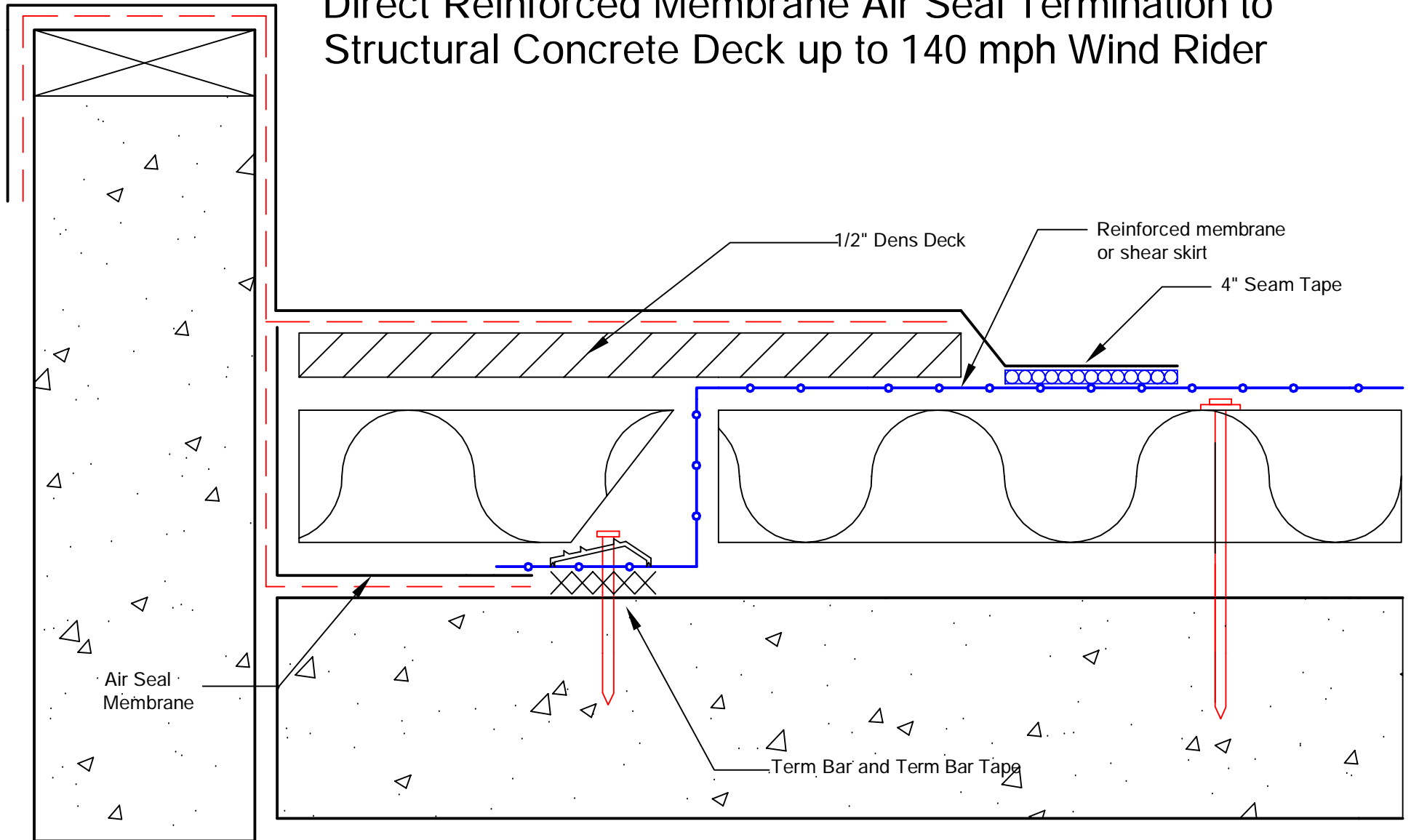







Direct Reinforced Membrane Air Seal Termination to Structural Concrete Deck up to 140 mph Wind Rider



	4" Seam Tape		1/2" Fiber Rock
	Adhesive		Concrete
	Insulation		
	Air Seal Rope		

Direct Membrane Termination	
Dwg #:	Drawn by:
Rev. Date:	Approved by:
Dwg. Date: 5/15/06	Scale: NTS

2001 Company

325 Thomaston Av.
P.O. Box 2557
Waterbury, CT 06702-2557

© Thomas L. Kelly - Patent Pending